

Impulse Air Range

IP15-AIR Technical Data Sheet

milkrite Product Code	milkrite Part Number	Compatible Claw
IP15-AIR	200002-01	Fits claws with 12-13mm OD nipples with angled cut

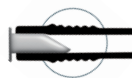

Material Approval



The compound used for this liner meets BFR Food Regulation XXI Category 3 for products that come into contact with food, and is approved to this standard by RAL. Our materials are REACH compliant

Liner Map - To Optimise Performance

Liner maps have been developed through independent research and testing on farm. You will find a copy of the liner map in the Impulse Air Dealer Manual. Use the liner maps to set the optimum conditions to achieve the desired output with the best teat condition

Shell Options

PLASTIC WEIGHT



Plastic shell / Plastic weight option
Weights : Shell - 122g
: Plastic Weight - 17g
: Total - 139g
Total weight of liner, shell and plastic weight - 269g

STAINLESS STEEL WEIGHT



Plastic shell / Stainless steel weight option
Weights : Shell - 122g
: Steel weight - 126g
: Total - 248g
Total weight of liner, shell and stainless steel weight - 378g

impulseAir®

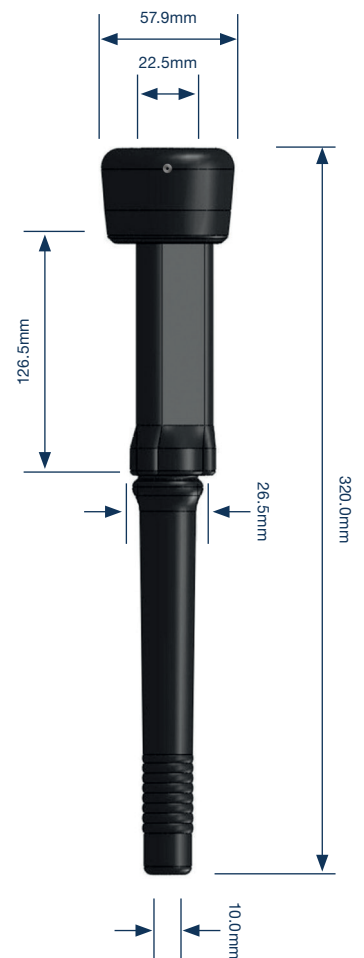

Warranty

milkrite liners are warranted to last a minimum of 2500 milkings or six months when used in accordance with our instructions and those of the parlour manufacturer.

The information in this document is not binding and can be changed without notice. Parlours and herds vary considerably, so these details are meant to be guidelines to operation only and not a specification. It remains the responsibility of the operator to ensure the correct working of the plant and the health of the animal.

milkrite, Hampton Park West, Semington Road, Melksham, Wiltshire SN12 6NB, UK



www.milkrite-interpuls.com

milkrite | InterPuls
Improving every farm we touch