



ultraliner[®]

ROUND LINER RANGE

WS240U - TECHNICAL DATA SHEET

Milkrite Product Code	Milkrite Part Number	Compatible With
WS240U	200108-01	7021-2725-240

Material Approval



The compound used for this liner meets BfR Food Regulation XXI Category 3 for products that come into contact with food, and is approved to this standard by RAL.

Shell Type: Milkrite - M10AV014XZ

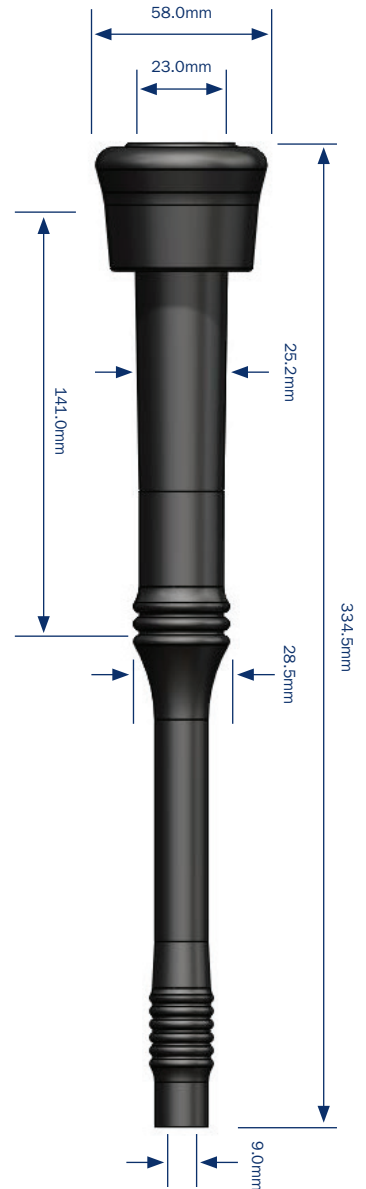
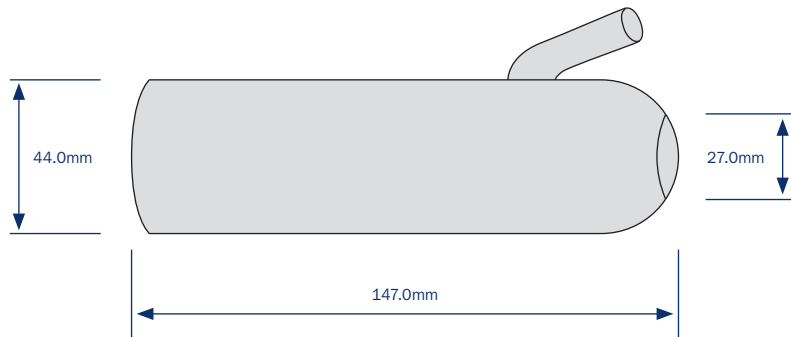

Milkrite Warranty

Milkrite liners are warranted to last a minimum of 2500 milkings or six months when used in accordance with our instructions and those of the parlour manufacturer.

The information in this document is not binding and can be changed without notice. Parlours and herds vary considerably, so these details are meant to be guidelines to operation only and not a specification. It remains the responsibility of the operator to ensure the correct working of the plant and the health of the animal.

Milkrite, Hampton Park West, Semington Road, Melksham, Wiltshire SN12 6NB, UK

www.milkrite.com

References to other manufacturers by their company names, trademarks or product references are for product identification purposes and are used only to indicate the intended purpose of Milkrite products and their compatibility with the equipment of those manufacturers.